



The clean solution

# Liste de pièces

Upster U 400 M2

No. de série : SN10483606;SN10483607;SN10483608;SN10483609







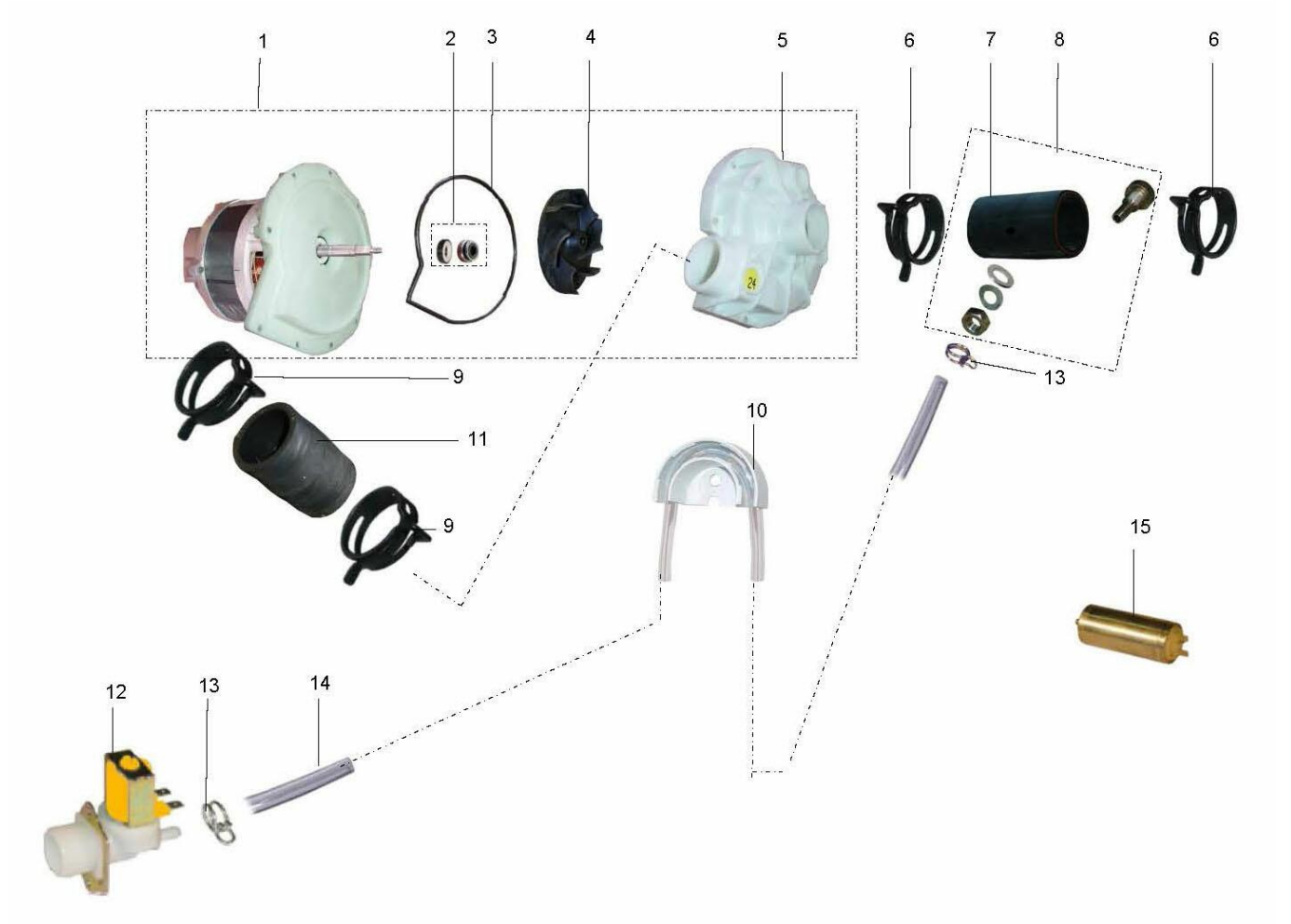

## Sommaire

01.35 POMPE DE LAVAGE .....	3
02.16 ASPIRATION DE POMPE .....	5
03.44 SYSTEME DE LAVAGE .....	7
04.37 ELECTROVANNE .....	10
05.01 DISPOSITIF ANTI-RETOUR .....	12
06.09 REGULATION DE NIVEAU .....	14
08.64 SURCHAUFFEUR INCORPORE .....	16
09.36 CHAUFFAGE DE BAC .....	18
10.18 DOSEURS .....	20
11.112 COMMAND DE ELECTRONIQUE .....	22
13.81 BLOCS / PIECES DETACHEES .....	24
18.32 POMPE DE VIDANGE .....	26
25.08 EQUILLIBRAGE DE POIDS DE PORTE .....	28
38.03 KIT D' ENTRETIEN .....	30

### 01.35 POMPE DE LAVAGE



## 01.35 POMPE DE LAVAGE

POS	INSCR.	N° IDENT.	DÉSIGNATION	DIMENSION
1		9623861	MOTOPOMPE	180-253VAC50HZ
2		0501095	GARNITURE ÉTANCHE À ANNEAU GLISSANT	
3		9500310	GARNITURE D'ÉTANCHÉITÉ	
4		0501137	ROTOR DE POMPE	D=96
5		9500311	CORPS DE POMPE	
6		9624002	PINCE POUR TUYAUX SOUPLES	N18
7		9630454	RACCORD POUR TUYAUX	
8		9630453	ENSEMBLE DE TUYAUX	
9		9624003	PINCE POUR TUYAUX SOUPLES	N50X12
10		9601265	PORTE-FLEXIBLE	D9
11		0640007	FLEXIBLE	40X5
12		9727394	ÉLECTROVANNE	G3/4"AXD6X24VAC/DCX50/60HZ
13		9500045	PINCE POUR TUYAUX SOUPLES	8,8-9,3
14		0260007	FLEXIBLE	6X1,5
15		0501090	CONDENSATEUR DE FONCTIONNEMENT	440V50/60HZ12UF

### Inscription des pièces de rechange



Nous recommandons de prendre ces pièces en stock !



Pièces de rechange recommandées !

## 02.16 ASPIRATION DE POMPE

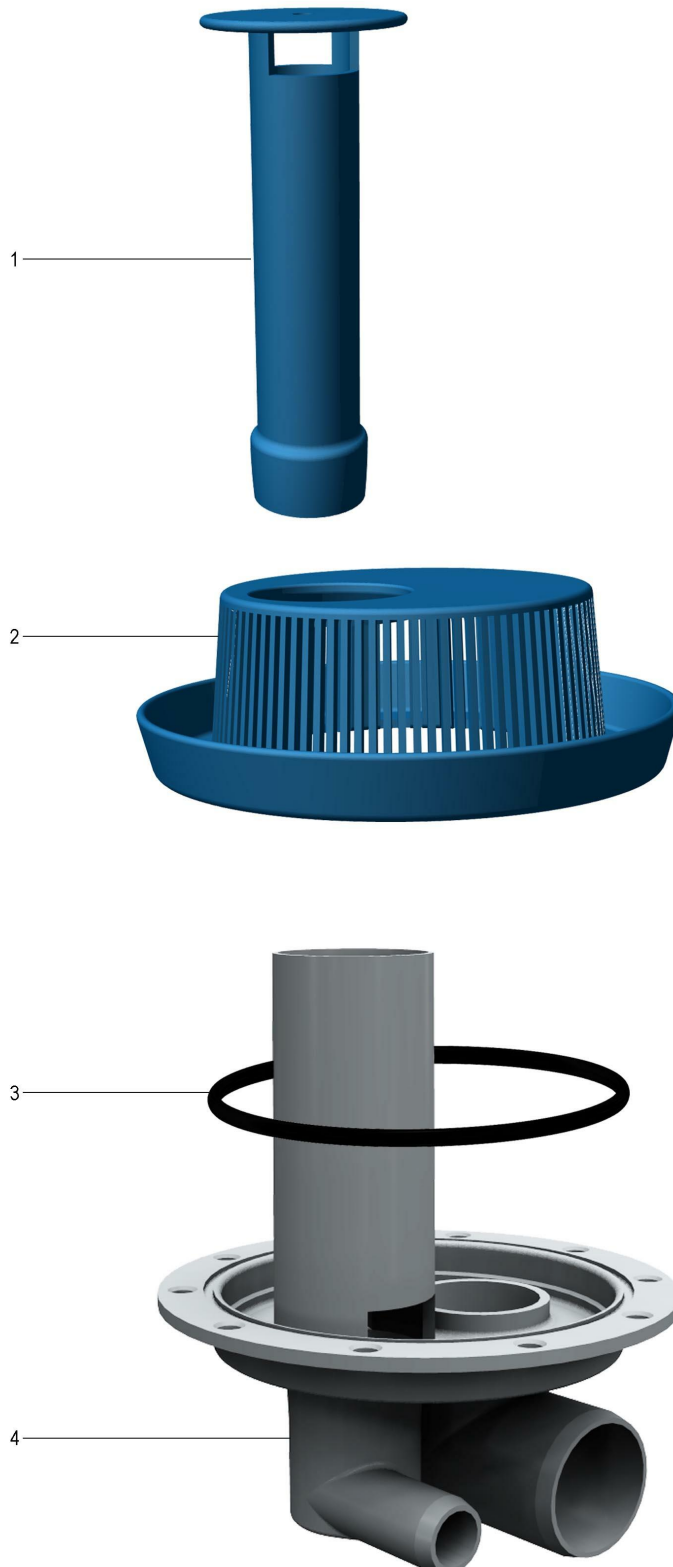

## 02.16 ASPIRATION DE POMPE

POS	INSCR.	N° IDENT.	DÉSIGNATION	DIMENSION
1		9753785	TROP-PLEIN ??	33X140
2		9753787	FILTRE	
3		0401070	JOINT TORIQUE	122X3 SHORE 70°
4		0620430	PUISARD D'ASPIRATION	

### Inscription des pièces de rechange



Nous recommandons de prendre ces pièces en stock !







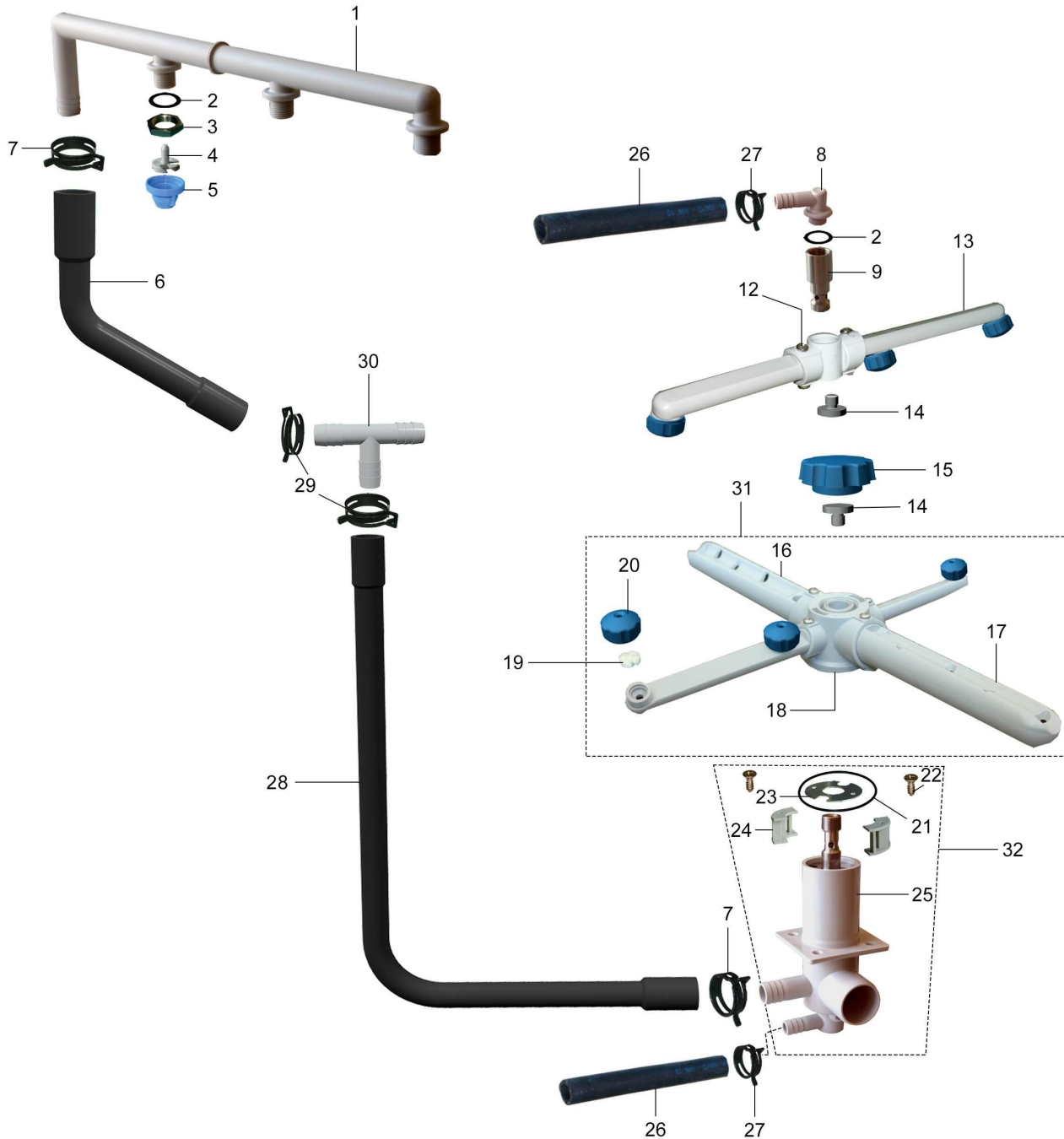





Pièces de rechange recommandées !

### 03.44 SYSTEME DE LAVAGE



### 03.44 SYSTEME DE LAVAGE

POS	INSCR.	N° IDENT.	DÉSIGNATION	DIMENSION
1		0620429	SUPPORT DE GICLEURS	
2		0217433	GARNITURE PLATE	17X24X2
3		0360211	ÉCROU BORGNE HEXAGONAL	SW 22X5 R3/8"
4		0620436	INSERT	
5		9753792	CAPUCHON	
6		9695885	PIÈCE MOULÉE DE FLEXIBLE	
7		9616022	PINCE POUR TUYAUX SOUPLES	N28
8		0620235	SUPPORT DE GICLEURS	R3/8"A
9		8003957	BOULON DE SERRAGE	21X50,2
10		8003886	BRAS DE RINÇAGE	
11		0620391	BRAS DE RINÇAGE	
12		0620394	MOYEU DE BRAS ROTATIF	
13		0620390	BRAS DE RINÇAGE	
14		0310010	VIS MOLETÉE	
15		9755956	CAPUCHON À VIS/ BOUCHON FILETÉ	
16		0620387	BRAS DE LAVAGE	
17		0620388	BRAS DE LAVAGE	
18		8004635	MOYEU DE BRAS ROTATIF	
19		0620121	PASTILLE DE DISPERSION	
20		9753799	GICLEUR	R3/8"IX2,5
21		0401030	JOINT TORIQUE	50X1,5 SHORE 75°
22		0260072	VIS	
23		8004179	CLAPET D'ÉTRANGLEMENT	D43,1/17
24		0620446	ADAPTATEUR	
25		0620432	PALIER DE BRAS ROTATIF	
26		9625600	RACCORD POUR TUYAUX	
27		9607418	PINCE POUR TUYAUX SOUPLES	N21

#### Inscription des pièces de rechange



Nous recommandons de prendre ces pièces en stock !



Pièces de rechange recommandées !



### 03.44 SYSTEME DE LAVAGE

POS	INSCR.	N° IDENT.	DÉSIGNATION	DIMENSION
28		9703020	PIÈCE MOULÉE DE FLEXIBLE	
29		9703053	PINCE POUR TUYAUX SOUPLES	N24
30		9700040	CONNEXION EN T	84X42X18
31		8004683	BRAS DE LAVAGE	
32		8004433	PALIER DE BRAS ROTATIF	

#### Inscription des pièces de rechange



Nous recommandons de prendre ces pièces en stock !





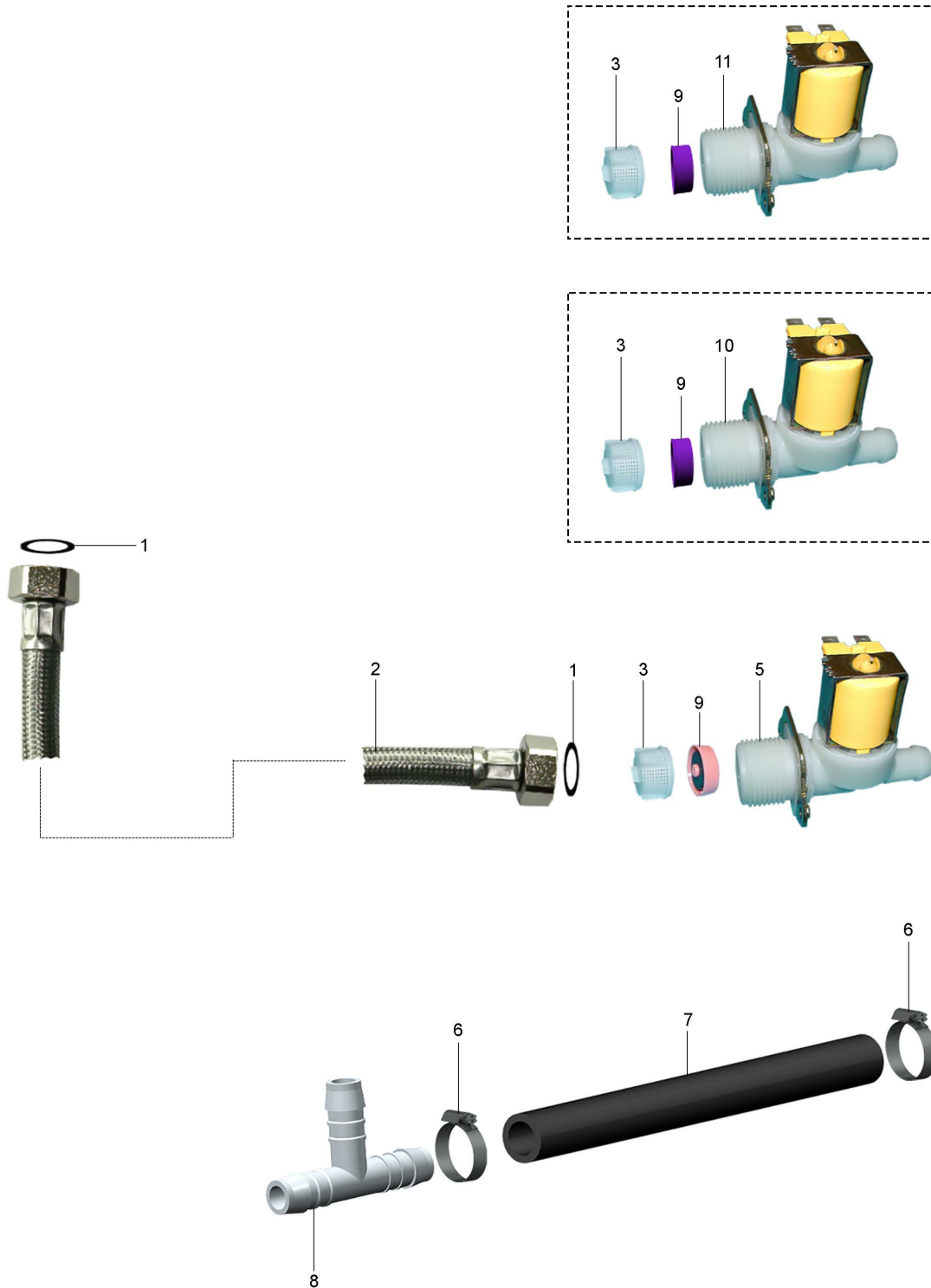

Pièces de rechange recommandées !

### 04.37 ELECTROVANNE



## 04.37 ELECTROVANNE

POS	INSCR.	N° IDENT.	DÉSIGNATION	DIMENSION
1		0408225	GARNITURE PLATE	
2		9505089	TUYAU MÉTALLIQUE FLEXIBLE	3/4"X2000X3/4"
3		0113098	FILTRE	
4		9506227	RÉGULATEUR DE DÉBIT	
5		9615830	ÉLECTROVANNE	G3/4"AXD13X24VAC
6		0233043	PINCE POUR TUYAUX SOUPLES	12-22
7		9608600	FLEXIBLE	13X3,5
8		0621035	PIÈCE EN T	

### Inscription des pièces de rechange



Nous recommandons de prendre ces pièces en stock !



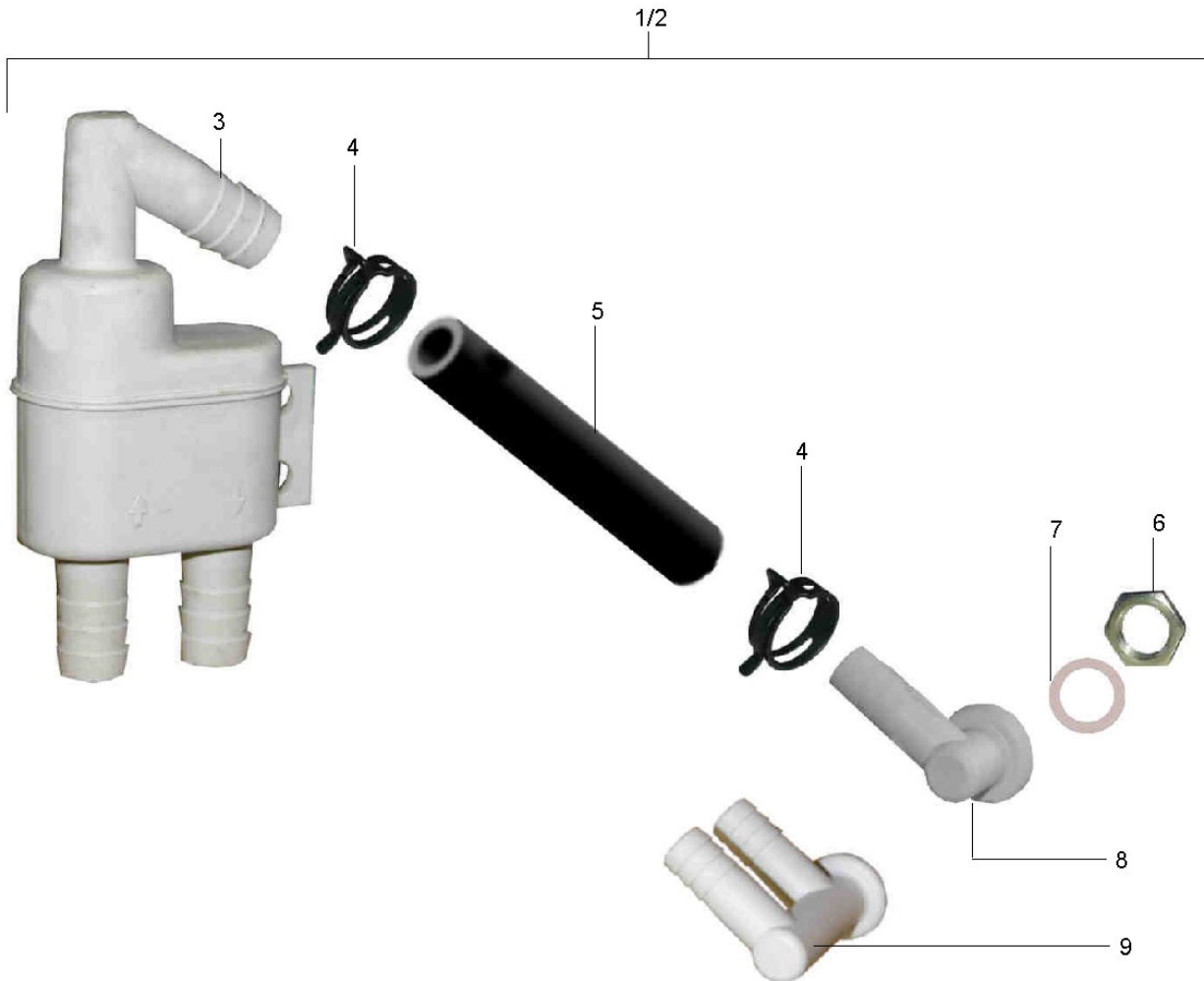

Pièces de rechange recommandées !

### 05.01 DISPOSITIF ANTI-RETOUR



**05.01 DISPOSITIF ANTI-RETOUR**

POS	INSCR.	N° IDENT.	DÉSIGNATION	DIMENSION
1		8002731	RESTRICTEUR DE FLUX DE RETOUR	
3		0620334	RESTRICTEUR DE FLUX DE RETOUR	1/2"
4		9607418	PINCE POUR TUYAUX SOUPLES	N21
5		9608600	FLEXIBLE	13X3,5
6		0360211	ÉCROU BORGNE HEXAGONAL	SW 22X5 R3/8"
7		0217433	GARNITURE PLATE	17X24X2
8		0620342	RACCORD DE TUYAU	

**Inscription des pièces de rechange**

Nous recommandons de prendre ces pièces en stock !







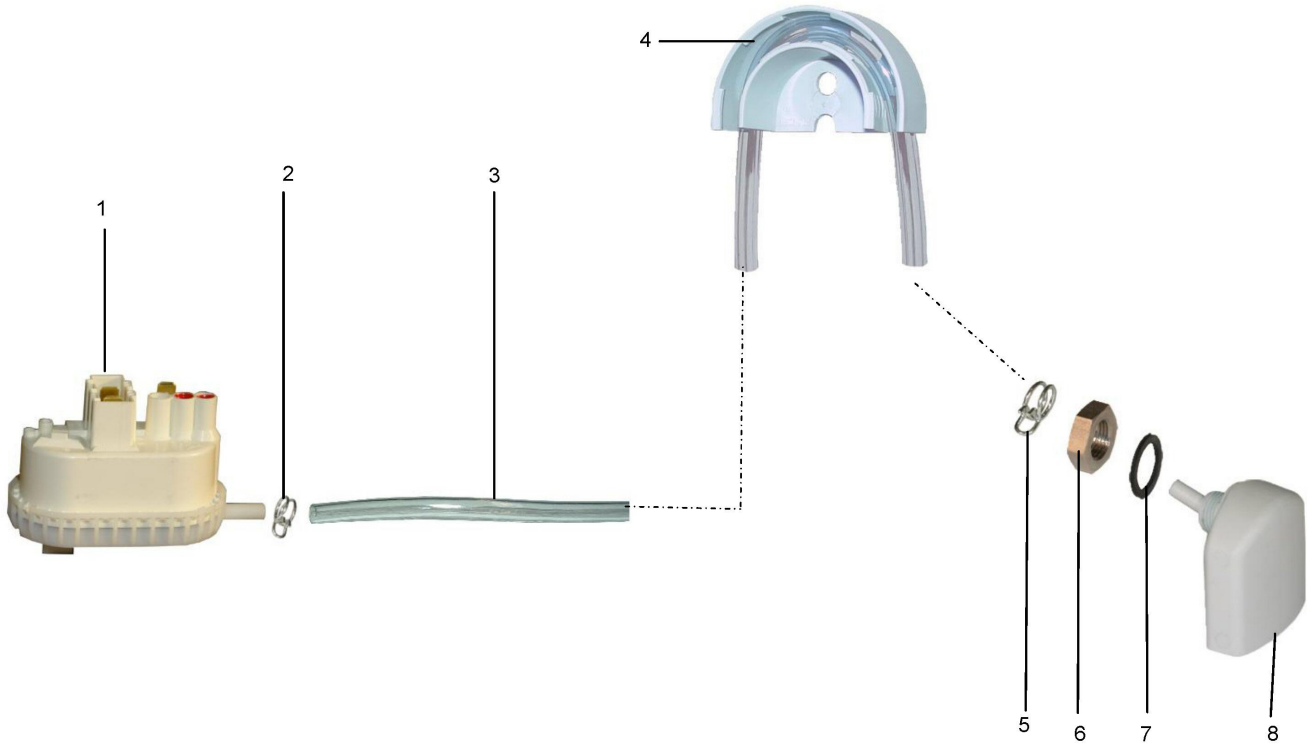

Pièces de rechange recommandées !

## 06.09 REGULATION DE NIVEAU



## 06.09 REGULATION DE NIVEAU

POS	INSCR.	N° IDENT.	DÉSIGNATION	DIMENSION
1		9741392	COMMUTATEUR DE NIVEAU	250VAC4A W
2		9500044	PINCE POUR TUYAUX SOUPLES	7,8-8,3
3		0260006	FLEXIBLE	5X1,5
4		9601265	PORTE-FLEXIBLE	D9
5		9500045	PINCE POUR TUYAUX SOUPLES	8,8-9,3
6		9515957	ÉCROU	M16X1,5
7		9515964	GARNITURE PLATE	19X26X2
8		9515955	PIÈGE À AIR	

### Inscription des pièces de rechange



Nous recommandons de prendre ces pièces en stock !





Pièces de rechange recommandées !

### 08.64 SURCHAUFFEUR INCORPORE





**08.64 SURCHAUFFEUR INCORPORE**

POS	INSCR.	N° IDENT.	DÉSIGNATION	DIMENSION
1		9732243	SURCHAUFFEUR	0,80 D150X430
2		9703586	RADIATEUR À EAU	230V3,0KW GERADE
3		0335300	ÉCROU HEXAGONAL SS	M5
4		9726489	JOINT TORIQUE	47X6 SHORE 50°
5		9608600	FLEXIBLE	13X3,5
6		9607418	PINCE POUR TUYAUX SOUPLES	N21
7		9707143	SONDE DE TEMPÉRATURE À RÉSISTANCE	D6,8/L32MM O.AKOPF KL0,4M
8		9639301	COLLIER DE CÂBLE	
9		0408008	GARNITURE PLATE	14X25X1,5
10		9513497	BOUCHON FILETÉ	M14 OR SW19
11		9681110	FLEXIBLE	6X3
12		9627394	PINCE POUR TUYAUX SOUPLES	N11,5
13		9672578	PIÈCE EN T	13X13X6

**Inscription des pièces de rechange**

Nous recommandons de prendre ces pièces en stock !



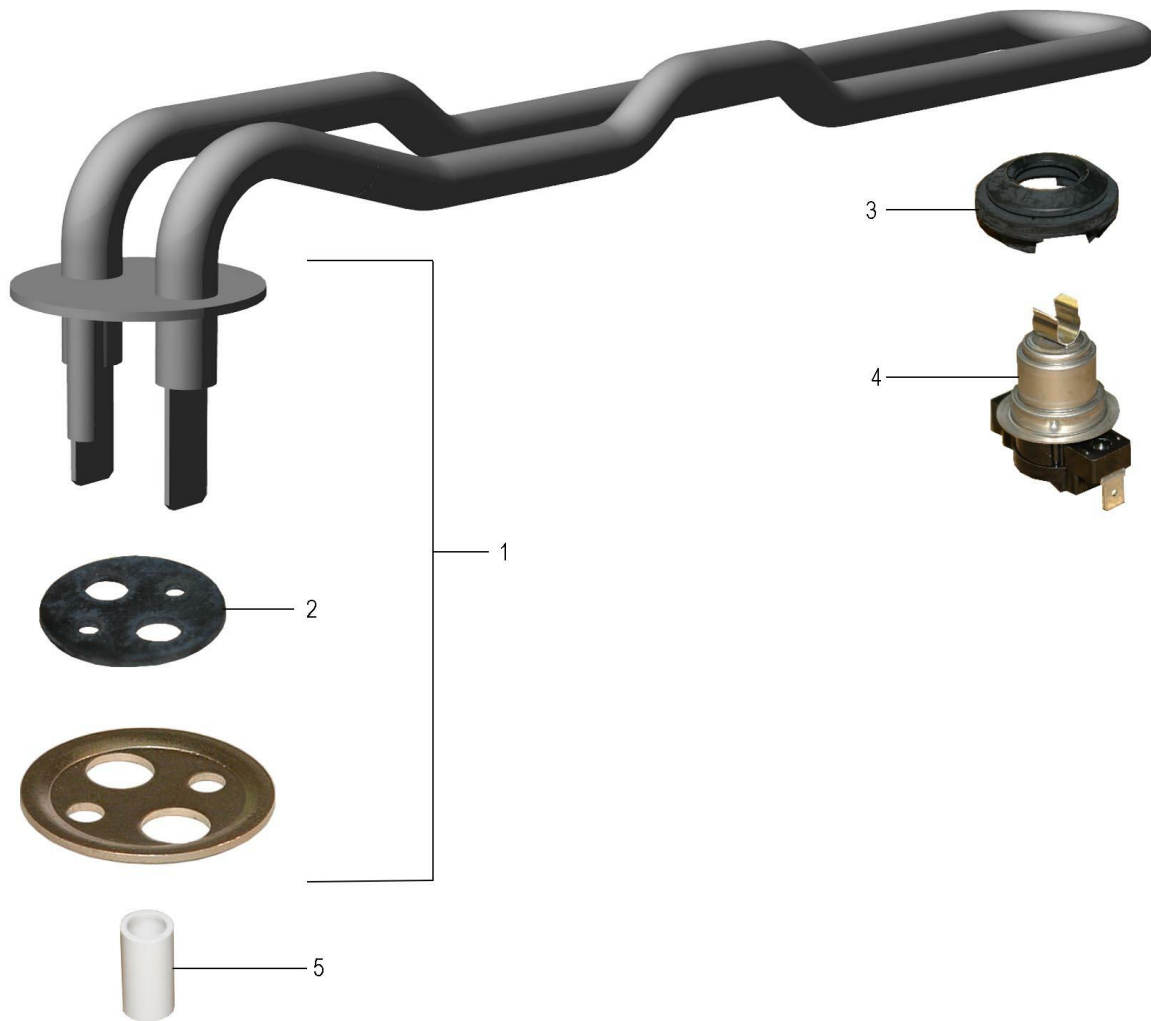

Pièces de rechange recommandées !

### 09.36 CHAUFFAGE DE BAC



## 09.36 CHAUFFAGE DE BAC

POS	INSCR.	N° IDENT.	DÉSIGNATION	DIMENSION
1		9754955	RADIATEUR À EAU	230V2KW GEBOGEN
2		0101175	GARNITURE D'ÉTANCHÉITÉ	
3		0108040	MANCHETTE / JOINT EN U	
4		9731011	KIT DE REMPLACEMENT	
5		9543319	PROTECTION CONTRE LES CONTACTS ACCIDENTELS	

### Inscription des pièces de rechange



Nous recommandons de prendre ces pièces en stock !







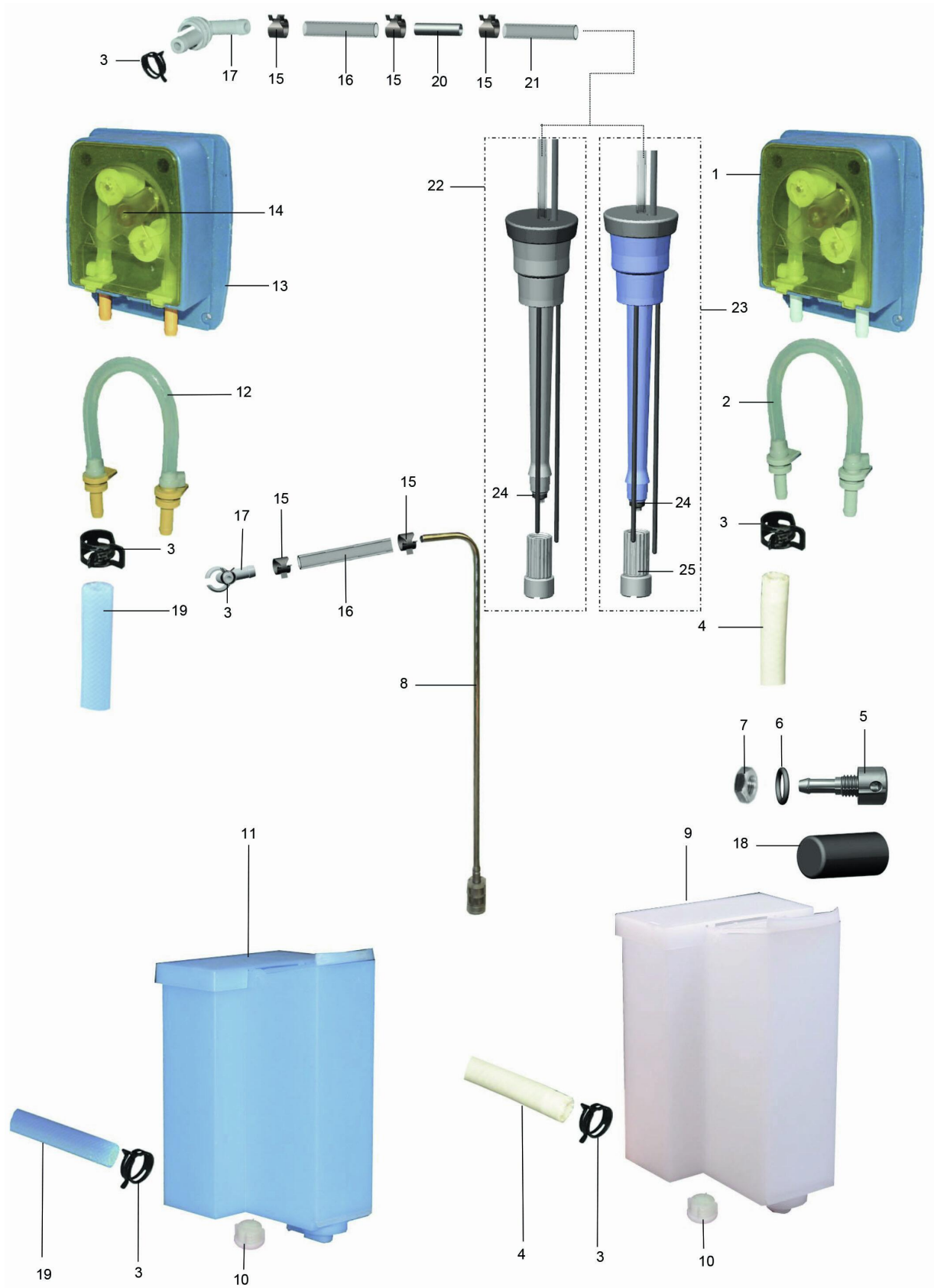



Pièces de rechange recommandées !

### 10.18 DOSEURS



## 10.18 DOSEURS

POS	INSCR.	N° IDENT.	DÉSIGNATION	DIMENSION
1		9544292	DOSEUR DE DÉTERGENT	D6 24VDC UL
2		9511675	FLEXIBLE	6X10 7L/H
3		9717749	PINCE POUR TUYAUX SOUPLES	N12,5
4		9647876	FLEXIBLE	6X3
5		9721635	RACCORDEMENT DOSEUR	D17-38
6		0401007	JOINT TORIQUE	10X2 SHORE 70°
7		0335019	ÉCROU BORGNE HEXAGONAL	M10
8		8005393	TUBULURE D'ASPIRATION	D6X0,5-340/47
12		9505652	FLEXIBLE	3X8 1L/H
13		9625978	DOSEUR DE PRODUIT DE RINÇAGE	24V
14		9533450	ROTOR	
15		9655015	PINCE POUR TUYAUX SOUPLES	8,9-9,3X8
16		0260007	FLEXIBLE	6X1,5
16		9538712	FLEXIBLE	6X1,5
17		9661146	DOUBLE RACCORD	
17		9665221	DOUBLE RACCORD	
19		9681110	FLEXIBLE	6X3

### Inscription des pièces de rechange



Nous recommandons de prendre ces pièces en stock !







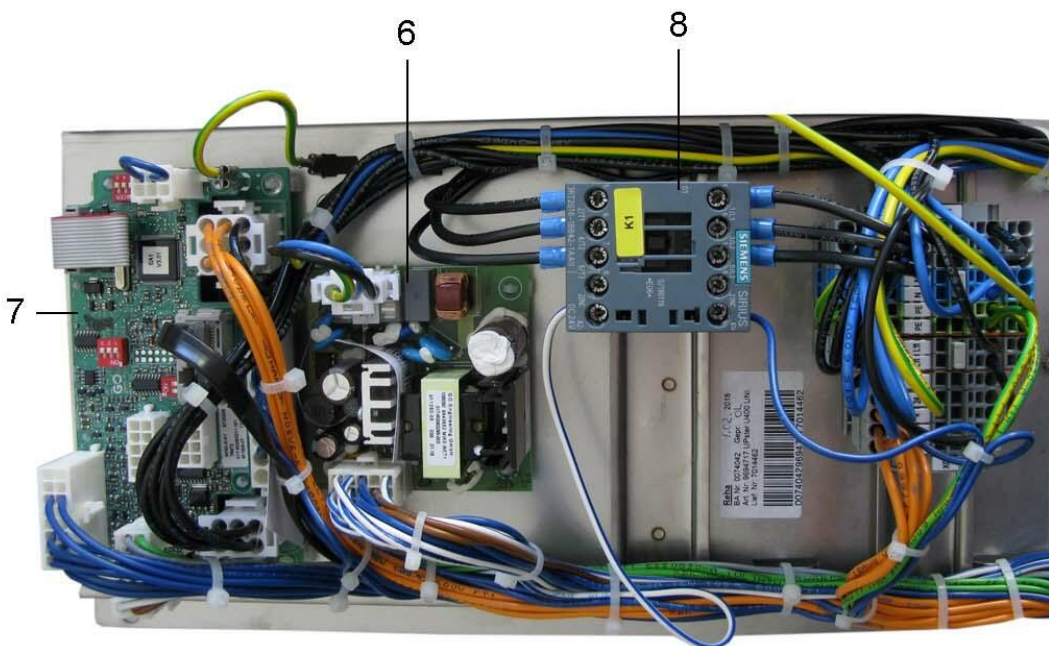
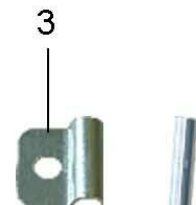
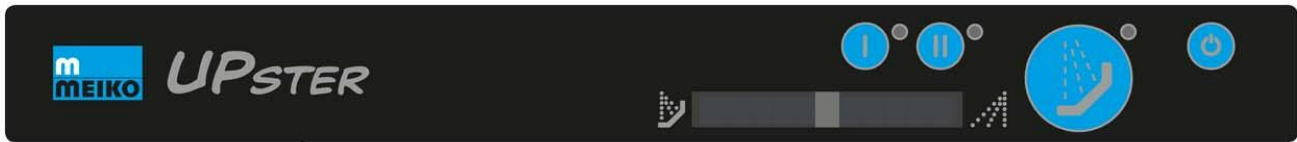





Pièces de rechange recommandées !

### 11.112 COMMAND DE ELECTRONIQUE



## 11.112 COMMAND DE ELECTRONIQUE

POS	INSCR.	N° IDENT.	DÉSIGNATION	DIMENSION
1		9751824	CLAVIER MEMBRANE	MIKE2 CPU1 1
2		9542049	MODULE	
3		9639363	SUPPORT	24X28
4		9621013	MODULE ÉLECTRONIQUE	GK ECOSTAR
5		9750396	SONDE DE TEMPÉRATURE À RÉSISTANCE	D6,8/L32MM O.AKOPF KL0,19M
6		9718836	PLATINE DU BLOC D'ALIMENTATION	180-264VPRIM 47-63HZ 12/24VDCSEK
7		9612715	COUPE-CIRCUIT AUTOMATIQUE	277V 16A B / TORQUE 3,0NM
7		9698805	EE-PROM PROGRAMMÉE	MIKE2 PROG 8KB
7		9764917	PLATINE E/S	MIKE
7		9621015	E-PROM	MIKE1 1 512KB
7		9611761	FUSIBLE POUR COURANT FAIBLE	16A T D5X20MM
7		0145047	FUSIBLE POUR COURANT FAIBLE	2,0A T D5X20MM
8		9763026	CONTACTEUR	24VDC 4KW 22/9A / TORQUE 1,2NM

### Inscription des pièces de rechange



Nous recommandons de prendre ces pièces en stock !



Pièces de rechange recommandées !

### 13.81 BLOCS / PIECES DETACHEES





**13.81 BLOCS / PIECES DETACHEES**

POS	INSCR.	N° IDENT.	DÉSIGNATION	DIMENSION
1		9730300-03	PAROI LATÉRALE	0,80
2		9734470	COUVERCLE / RECOUVREMENT	
3		9754017	PORTE	
4		9730300-04	PAROI LATÉRALE	0,80
5		9733957	CACHE FRONTAL	0,80
6		9730511	PANNEAU ARRIÈRE	1,00
7		9730436	TÔLE DE FOND	535X411
7		9505089	TUYAU MÉTALLIQUE FLEXIBLE	3/4"X2000X3/4"
7		0460035	CAPUCHON	D=25 M8

**Inscription des pièces de rechange**

Nous recommandons de prendre ces pièces en stock !



Pièces de rechange recommandées !

### 18.32 POMPE DE VIDANGE



## 18.32 POMPE DE VIDANGE

POS	INSCR.	N° IDENT.	DÉSIGNATION	DIMENSION
1		9733831	MOTOPOMPE	200-230VAC-10+10%50-60HZ
2		9607417	PINCE POUR TUYAUX SOUPLES	N30
3		9718060	PIÈCE MOULÉE DE FLEXIBLE	
4		9616022	PINCE POUR TUYAUX SOUPLES	N28
5		9651558	PIÈCE MOULÉE DE FLEXIBLE	D30X4-460
6		9502991	RACCORD DE TUYAU	
7		0401017	JOINT TORIQUE	22X2,5 SHORE 70°
8		9503011	RACCORD DE TUYAU	
9		0233045	PINCE POUR TUYAUX SOUPLES	20-32
10		9641540	FLEXIBLE	22X1600

### Inscription des pièces de rechange



Nous recommandons de prendre ces pièces en stock !



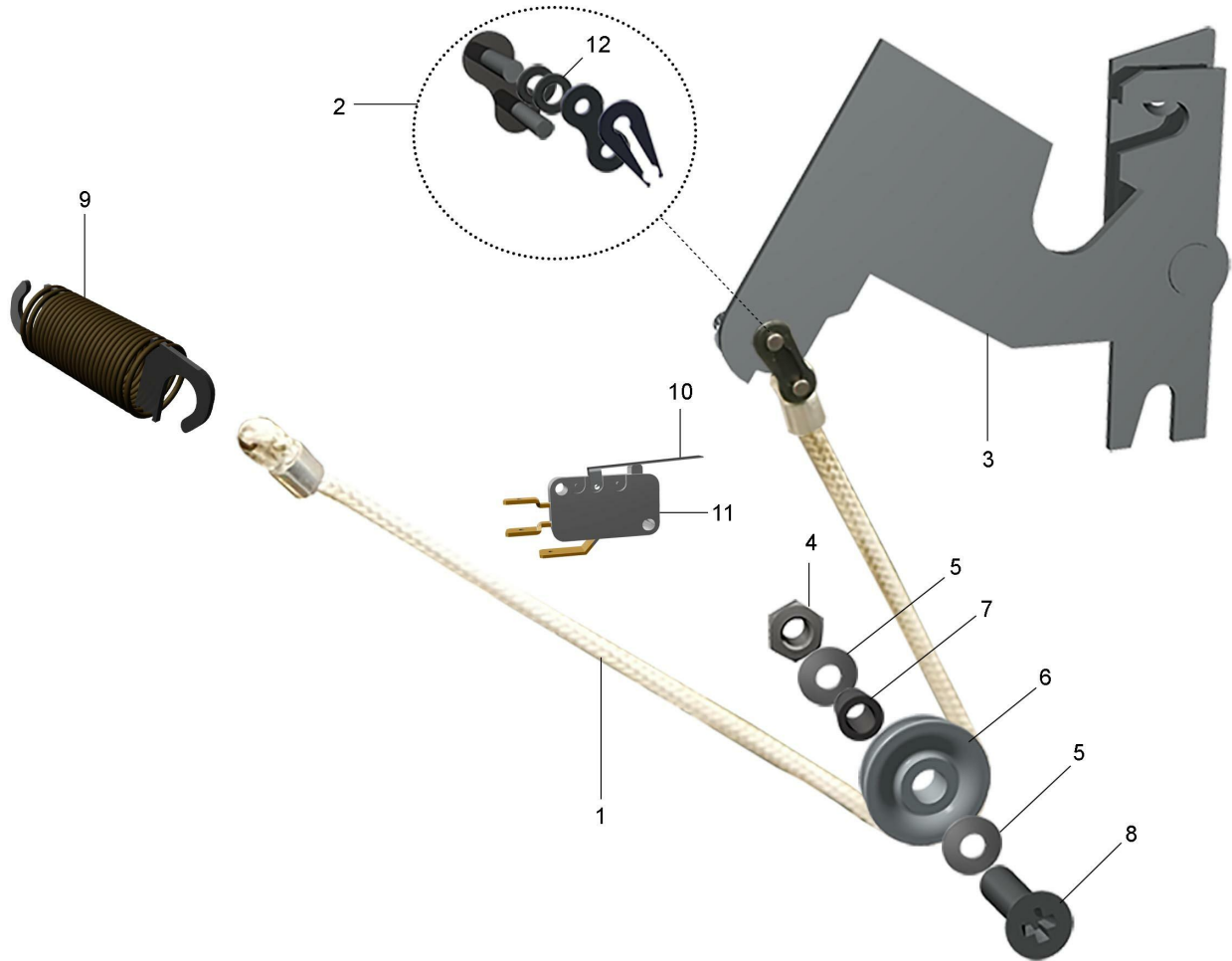

Pièces de rechange recommandées !

### 25.08 EQUILLIBRAGE DE POIDS DE PORTE



**25.08 EQUILIBRAGE DE POIDS DE PORTE**

POS	INSCR.	N° IDENT.	DÉSIGNATION	DIMENSION
1		0435151	CÂBLE / CORDAGE / FILIN	320X4MM
2		9721719	JOINT DE CHAÎNE / FAUX MAILLON	1/2 X1/8
3		8003985	PALIER	
3		8004426	PALIER	
4		0337001	ÉCROU HEXAGONAL SS	M5
5		0340020	DISQUE	M5X5,3X15X1,2
6		9600964	ROULEAU / GALET	
7		9520736	BAGUE DE PALIER	D8,3/5,1-10,3
8		0306121	VIS CRUCIFORME À TÊTE CONIQUE	M5X20
9		0430025	RESSORT DE TRACTION	1X81X14,5
10		0122106	LEVIER	
11		0122103	MICRORUPTEUR	250V/5A 1W
12		0340056	DISQUE	M6X6,4X12X1,6

**Inscription des pièces de rechange**

Nous recommandons de prendre ces pièces en stock !



Pièces de rechange recommandées !

Upster U 400 M2



No. de série : SN10483606;SN10483607;SN10483608;SN10483609

### 38.03 KIT D' ENTRETIEN

POS	INSCR.	N° IDENT.	DÉSIGNATION	DIMENSION
		9761679	KIT D'ENTRETIEN	

#### Inscription des pièces de rechange



Nous recommandons de prendre ces pièces en stock !



Pièces de rechange recommandées !





The clean solution



**MEIKO Maschinenbau GmbH & CO. KG**

Englerstraße 3

77652 Offenburg

Germany

[www.meiko-global.com](http://www.meiko-global.com)

[info@meiko-global.com](mailto:info@meiko-global.com)