

ID	Service parts	S-RS	Description
A-01	6.101.039.001	S	Foot (10 pcs)
A-02	6.101.033.001	S	Lower panel
A-03	6.101.072.000	RS	Hot plate
A-04	6.101.139.001	S	Upper panel (printed)
A-05	6.101.140.001	S	Upper panel (printed)
A-06	6.101.160.000	RS	Keyboard
A-07	6.101.027.001	S	Upper panel
A-08	6.101.047.000	RS	Mainboard (STD)
A-09	6.101.151.000	RS	Mainboard (GB)
A-10	6.101.101.000	RS	Mainboard (STA)
A-11	6.002.019.150	S	Wire clamp
A-12	6.006.001.019	S	Cord inlet
A-13	6.005.011.021	S	Fuse 5A (10 pcs)

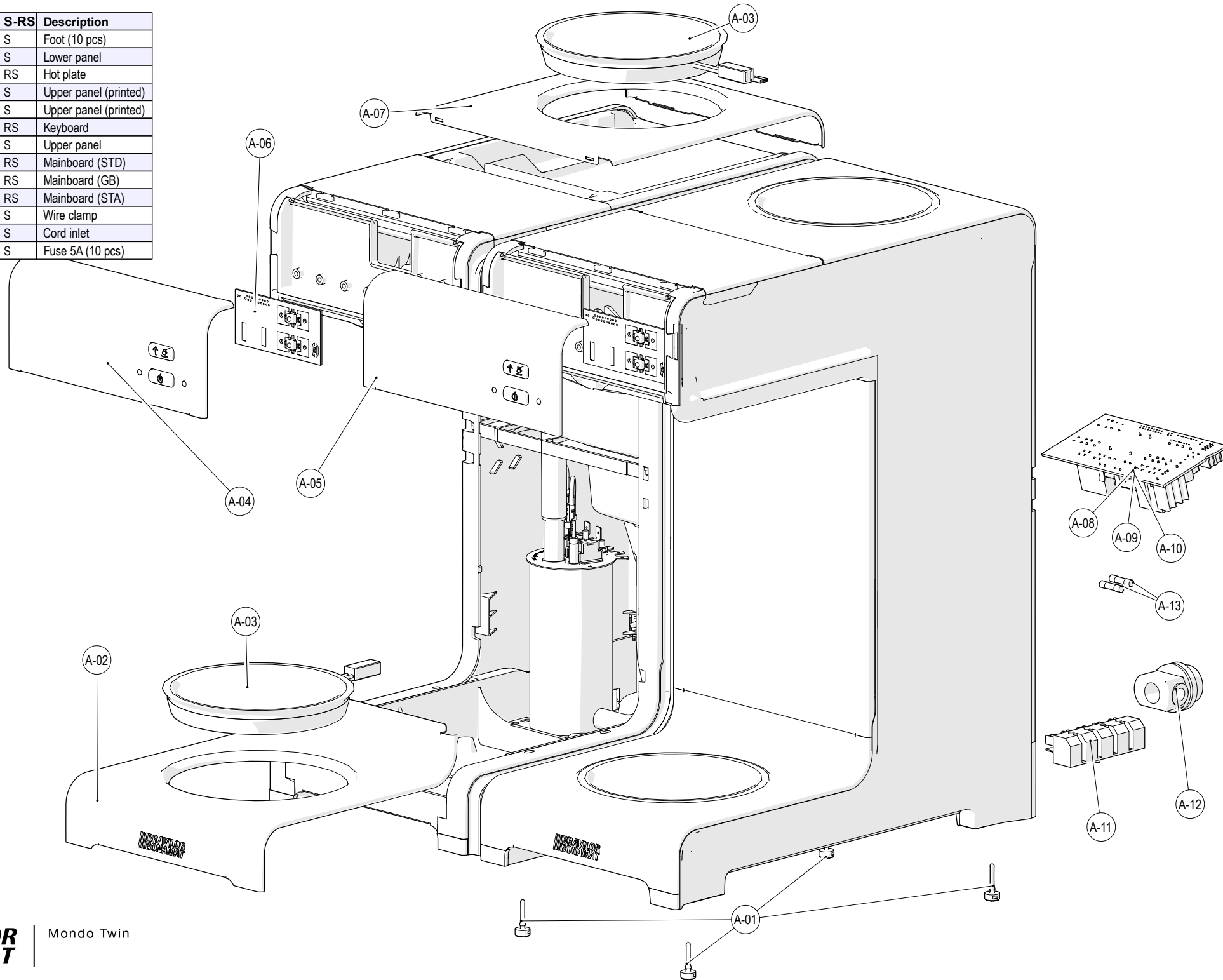

ID	Service parts	S-RS	Description	mm
B-01	6.101.011.001	S	Grid watertank	
B-02	6.101.105.001	S	Locking device	
B-03	6.101.093.001	RS	Float	
B-04	6.101.113.000	RS	Reed contact	
B-05	6.101.081.001	S	Silicone tube 9.5 x 3.0	200
B-06	6.101.137.000	RS	Flow boiler 240V 1400W	
B-07	6.101.061.000	RS	Flow boiler 230V 2000W	
B-08	6.101.133.000	RS	Flow boiler 230V 1600W	
B-09	6.101.080.001	S	Silicone tube 11,5 x 3,0	280
B-10	6.101.008.001	S	Water spreader (assy)	
B-11	6.011.001.157	S	O-ring 75x3x3	
B-12	6.101.062.001	S	Spraying tank	
B-13	6.016.008.077	RS	High temp safety device	

