

SECTION 4. PARTS INFORMATION

4-1. INTRODUCTION

This section lists the replaceable parts of the Henny Penny AHC-993 and AHC-990.

4-2. GENUINE PARTS

Use only genuine Henny Penny parts in your cabinet. Using a part of lesser quality or substitute design may result in damage to the unit, or personal injury.

4-3. WHEN ORDERING PARTS

Once the parts that you want to order have been found in the parts list, write down the following information:

Example:	Item Number	<u>4</u>
	Part Number	<u>16684</u>
	Description	<u>Cooling Fan</u>

From data plate, list the following information:

Example:	Product Number	<u>HHC990.0</u>
	Serial Number	<u>AW001IE</u>
	Voltage	<u>208 Volt</u>

4-4. PRICES

Your distributor has a price list and will be glad to inform you of the cost of your parts order.

4-5. DELIVERY

Commonly replaced items are stocked by your local distributor and will be sent out when your order is received. Other parts will be ordered, by your distributor, from Henny Penny Corporation.

4-6. WARRANTY

All replacement parts (except lamps and fuses) are warranted for 90 days against manufacturing defects and workmanship. If damage occurs during shipping, notify the carrier at once so that a claim may be properly filed. Refer to warranty in the front of the manual for other rights and limitations.

4-7. RECOMMENDED SPARE PARTS FOR DISTRIBUTORS

Recommended replacement parts, stocked by your distributor, are indicated with √ in the parts lists. Please use care when ordering recommended parts, because all voltages and variations are marked. Distributors should order parts based upon common voltages and equipment sold in their territory.

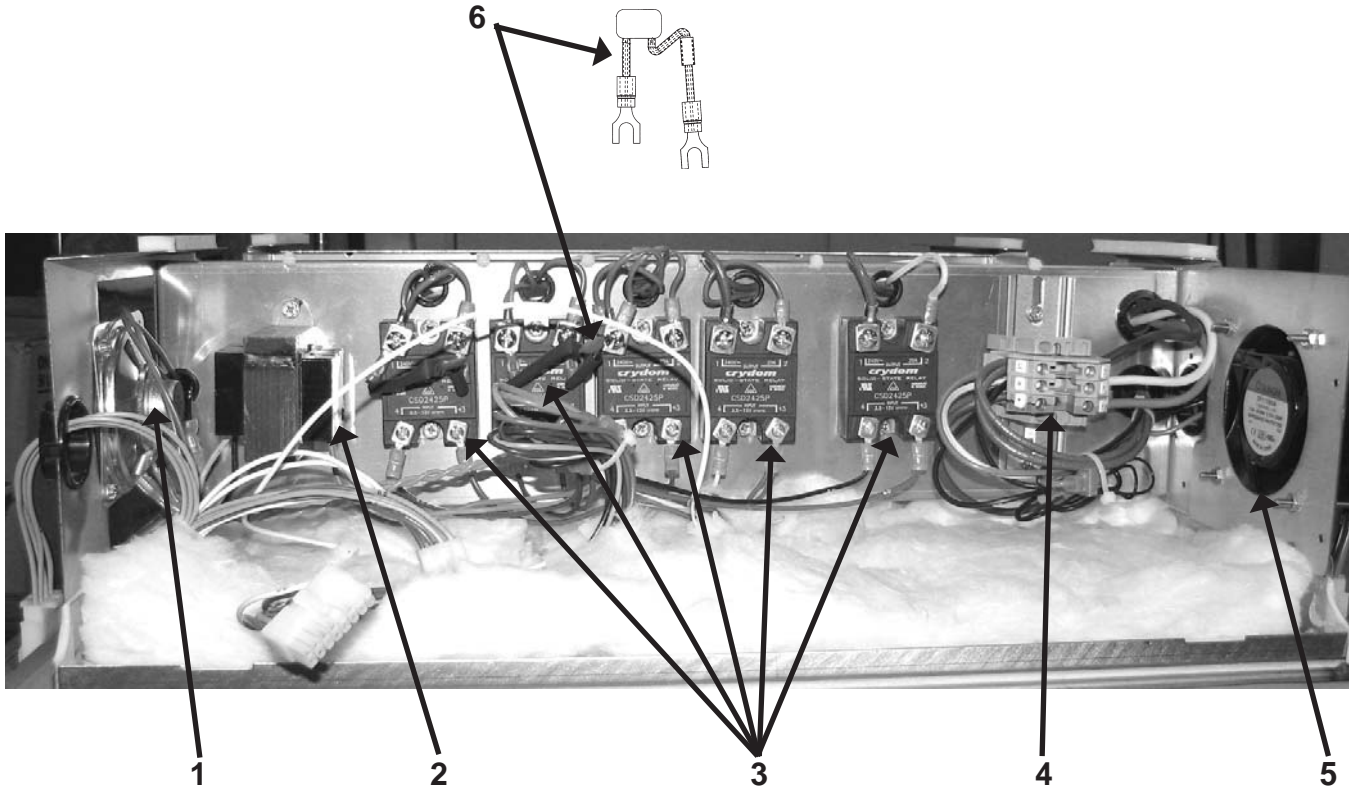

Item No.	Part No.	Description	Quantity	
			AHC-993	AHC-990
√ 1	63419	Speaker Assembly	1	1
√ 2	63460	Transformer Assembly - 120V Pri.-24 Sec.	1	1
√ 3	40645	Relay - 25A - Solid State	5	5
4	63832	Terminal Block Assembly	1	1
√ 5	16684	Cooling Fan Assy - 120V	1	1
√ 6	66879	Assy - Resistor Capacitor	2	2
√ 7*	51068	Assy - EMC Filter Board - CE	1	1

√ recommended parts

*not shown

AHC-990 Floor Model

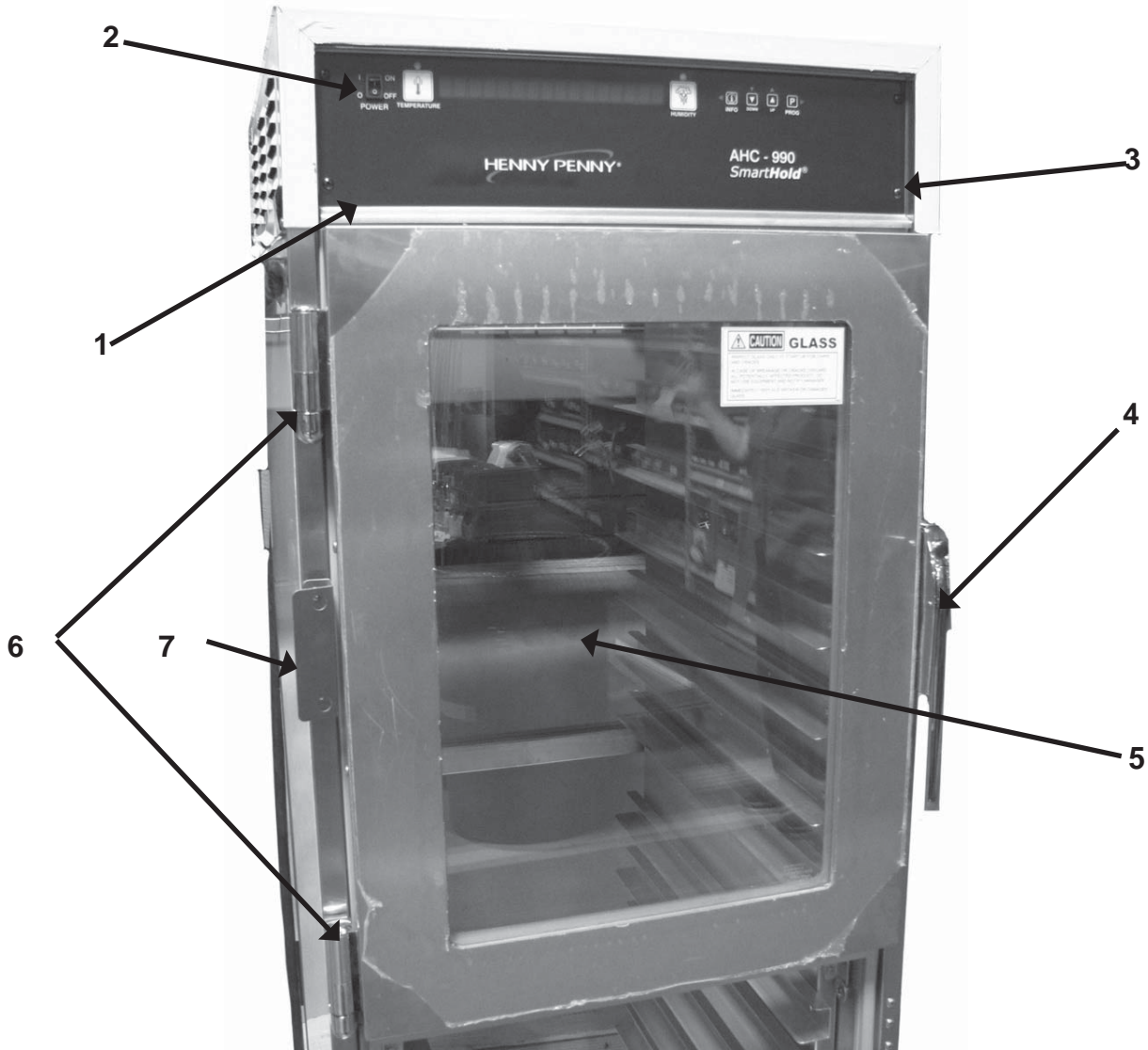

Item No.	Part No.	Description	Quantity
√1	88747	Kit - Control Board	1
√2	63464	Power Switch	1
3	90730	Decal - Control AHC-990	1
4	14272	Kit - Door Handle	2
5	32768	Assy - AHC-990 Glass Door - RH Top	2
5	32769	Assy - AHC-990 Glass Door - RH Bottom	2
5	32770	Assy - AHC-990 Glass Door - LH Top	2
5	32771	Assy - AHC-990 Glass Door - LH Bottom	2
6	14271	Kit - Door Hinge	4
7	27149	Door Stop	4
8*	86850	Service Pack - 5 in. Casters	1
	27154	Caster - 5 in. Swivel - Locking	2
	27155	Caster - 5 in. Swivel	2
	LW01-002	Lockwasher Split Ring - 1/4	16
	SC01-039	Screw - 1/4-20 x 1 Hex Head	16

√ recommended parts/*not shown

AHC-993 Countertop Model

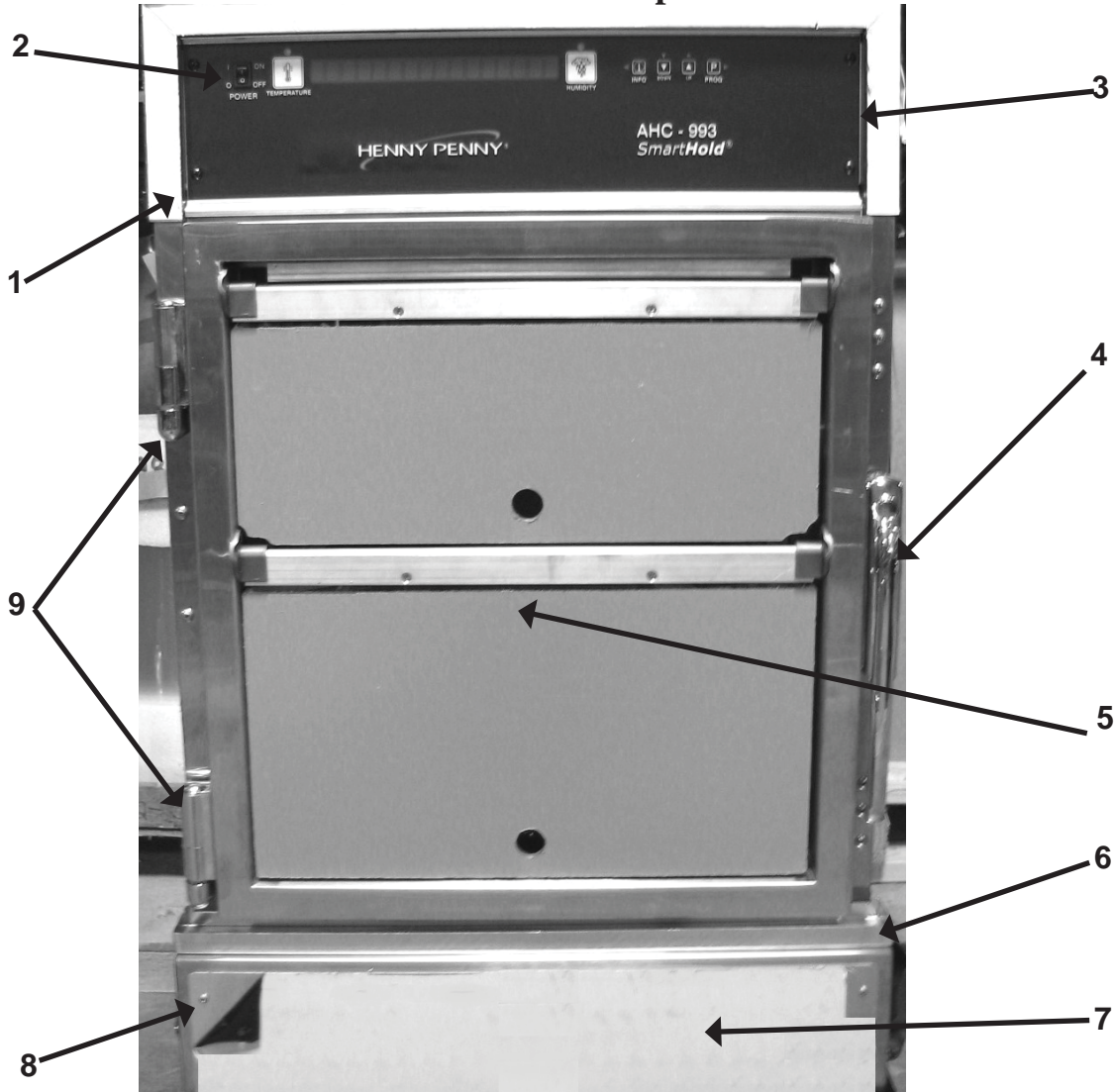

Item No.	Part No.	Description	Quantity
√1	88747	Kit - Control Board SN: DC1011047 & Before	1
√1	90165	Kit - Control Board SN: DC1011048 & After	1
√2	63464	Power Switch	1
3	89360	Decal - Control AHC-993	1
4	14272	Kit - Door Handle	2
5	87198	Assy-Door-Flip-RH-1/3 Size (Parts breakdown on next page)	1
5	87934	Assy-Door-Flip-LH-1/3 Size (Parts breakdown on next page)	1
6	88490	Shroud - Base	1
7	89260	Plate - Service Access	2
8	SC06-026	Screw	4
9	14271	Kit - Door Hinge	4
10*	03681	Tray Accessory - AHC-993	1

√ recommended parts/*not shown

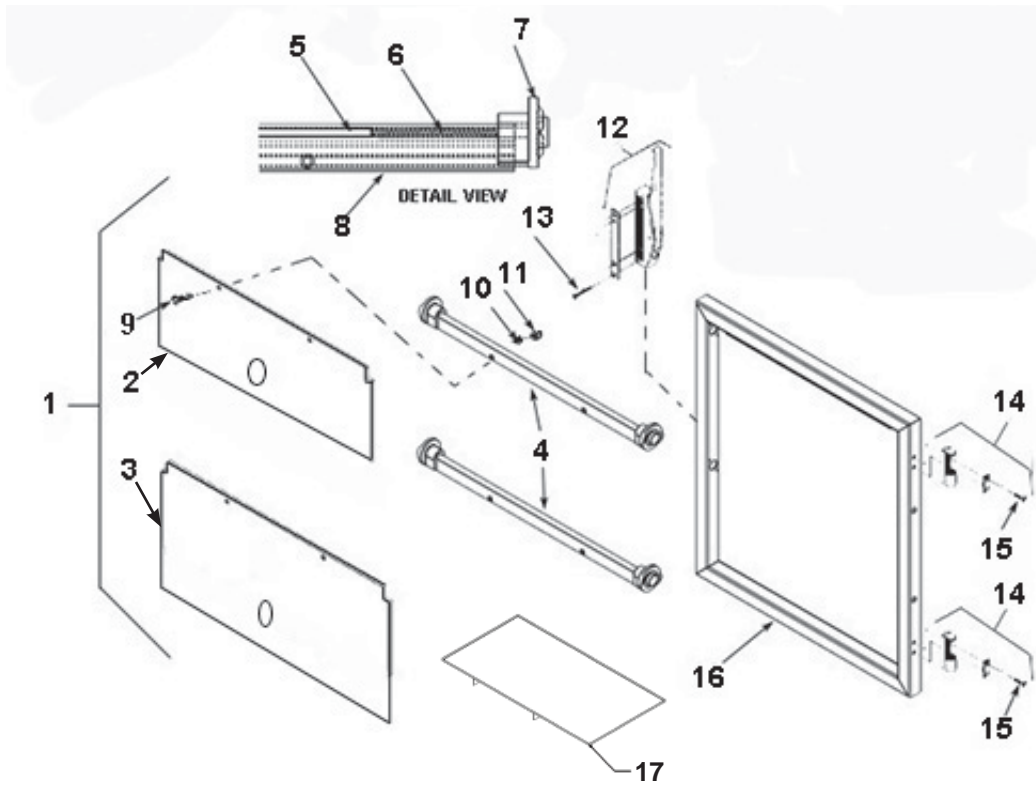

Item No.	Part No.	Description	Qty Per Door
1	87198	Assy-Door-Flip-RH-1/3 Size	1
1	87934	Assy-Door-Flip-LH-1/3 Size	1
2	75544-006	Panel-Flip Door-7.848" Height	1
3	75544-007	Panel-Flip Door-10.860" Height	1
4	71308	Assy-Hinge-Panel-Door-Flip	2
5	71067	Rod-Flip-Door	2
6	71316	Spring-Flip Door	2
7	70768	Cam-Flip Door-RH	2
7	70769	Cam-Flip Door-LH	2
8	73320	Extrusion-Flip Door	2
9	SC01-032	Screw	4
10	LW02-006	Lockwasher	4
11	NS03-024	Nut	4
12	14272	Kit-Door Handle	1
13	SC01-186	Screw	4
14	14271	Kit-Door Hinge	2
15	SC01-086	Screw	4
16	87199	Weld Assy-Flip Door Frame-RH-1/3 Size	1
16	87935	Weld Assy-Flip Door Frame-LH-1/3 Size	1
17	03557	Accessory-Flip Door Tray	1

√ recommended parts/*not shown

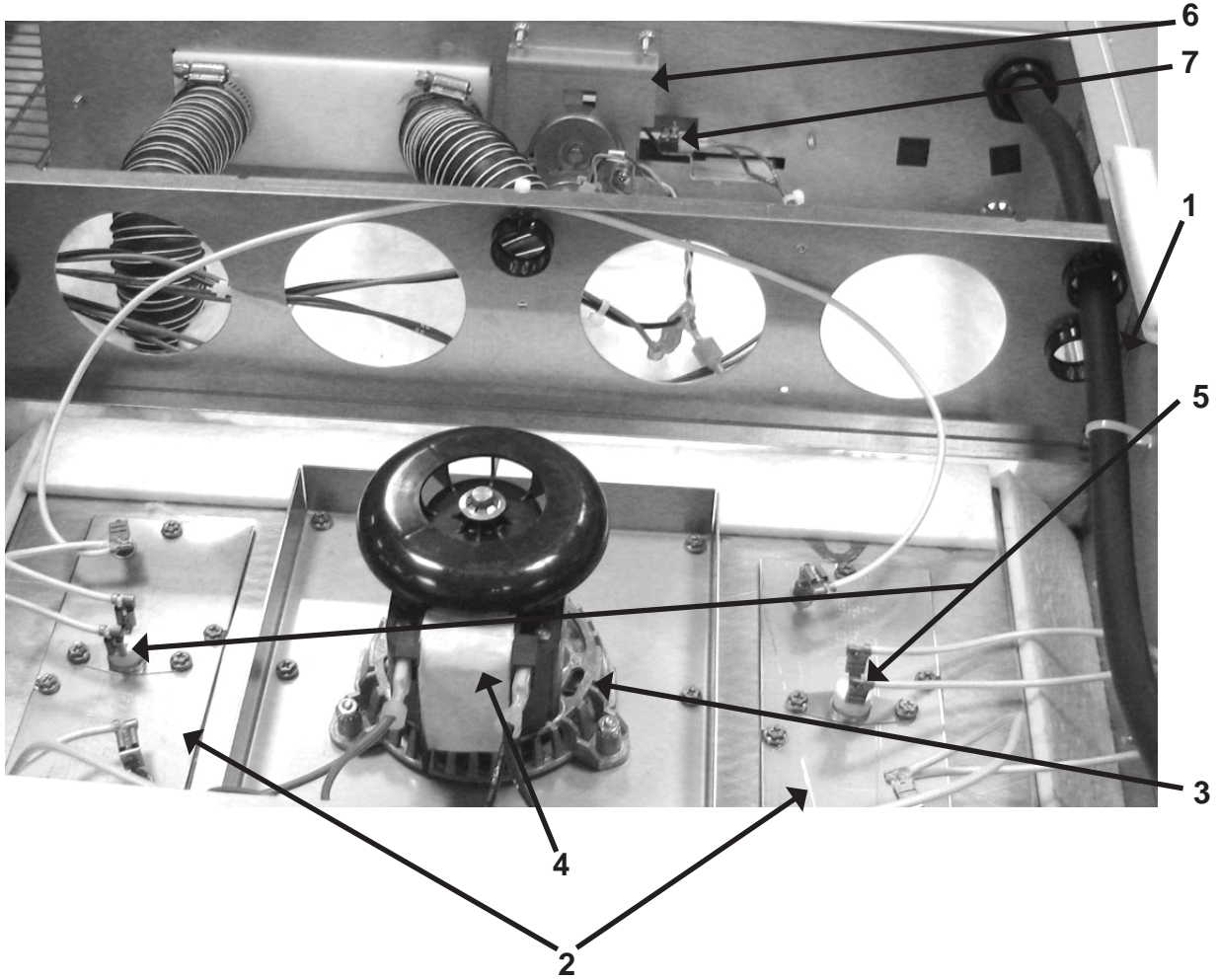

Item No.	Part No.	Description	Quantity
1	63928	Power Cord Assembly - 120V-20A-Straight - AHC-993	1
1	63870	Power Cord Assembly - 120V-30A - 90 Degree	1
1	63927	Power Cord Assembly - 120V-50A - 90 Degree (Canada/high watts)	1
1	63930	Power Cord Assembly - 208/240V-20A - Straight	1
1	63931	Power Cord Assembly - 208/240V-15A - Straight	1
√ 2	64126	Air Heater Assy-600W-120V (includes 63815 gasket)	2
√ 2	64127	Air Heater Assy-900W-120V (includes 63815 gasket)	2
√ 2	64128	Air Heater Assy-1000W-120V (includes 63815 gasket)	2
√ 2	64126	Air Heater Assy-600W-104V (includes 63815 gasket)	2
√ 2	64285	Air Heater Assy-1000W-104V (includes 63815 gasket)	2
√ 3	63360	Fan Blade - 5-3/8"	1
√ 4	63361	Blower - Motor 240V	1
√ 4	63362	Blower - Motor 208V	1
√ 4	63363	Blower - Motor 120V	1
√ 5	18201	Sensor - High Limit - 335 Deg.	2
√ 6	63829	Assy - Vent Motor - 110	1
√ 7	64098	Assy - Sealed Switch and Actuator	1
8*	63814	Gasket - Plate - Blower Motor Mounting	1

√ recommended parts/*not shown

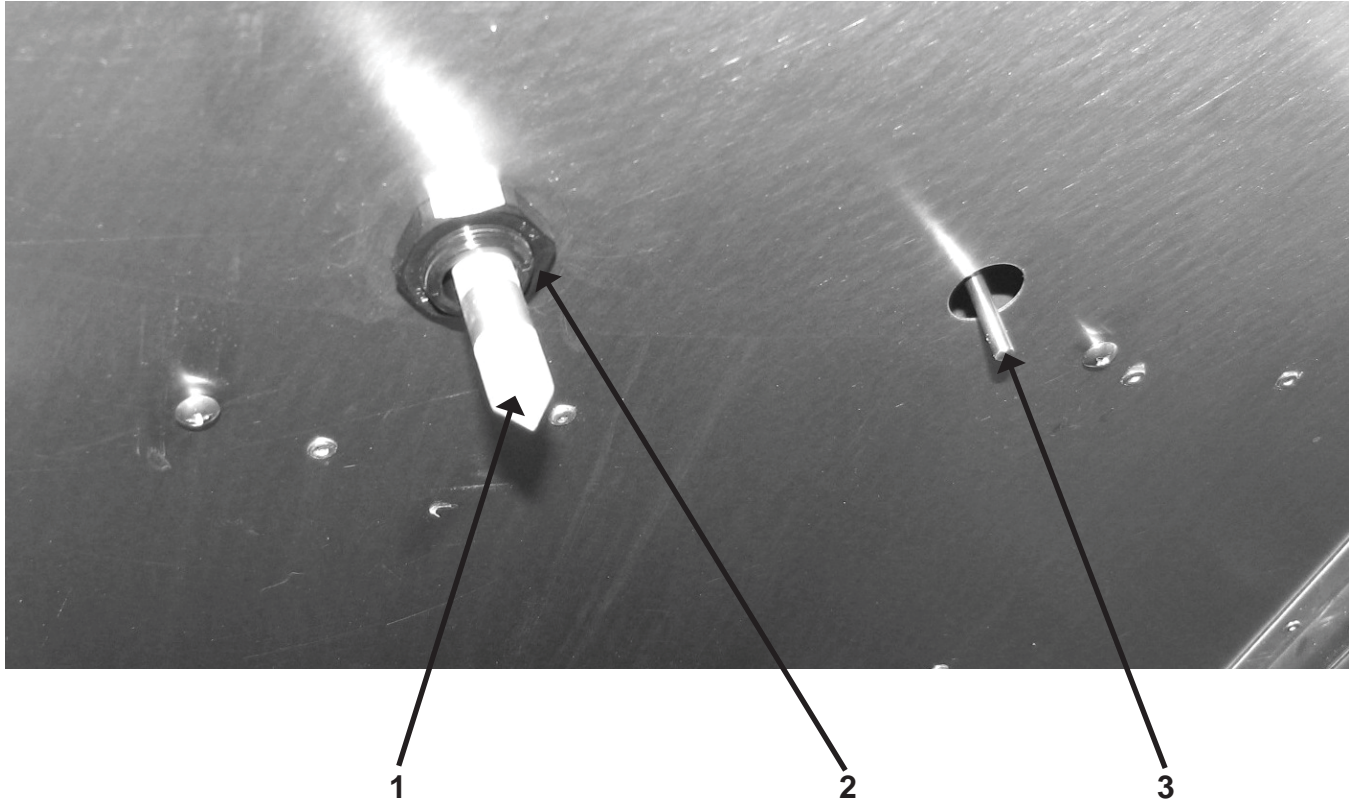

Item No.	Part No.	Description	Quantity
√ 1	14390	Kit - Humidity Sensor	1
2	EF02-124	Strain Relief	1
√ 3	81673	Probe-Air Temp	1
√ 4*	14391	Kit - Calibration Board	1
5*	59383	Assy - Sensor Housing and Bracket	1

√ recommended parts / * not shown

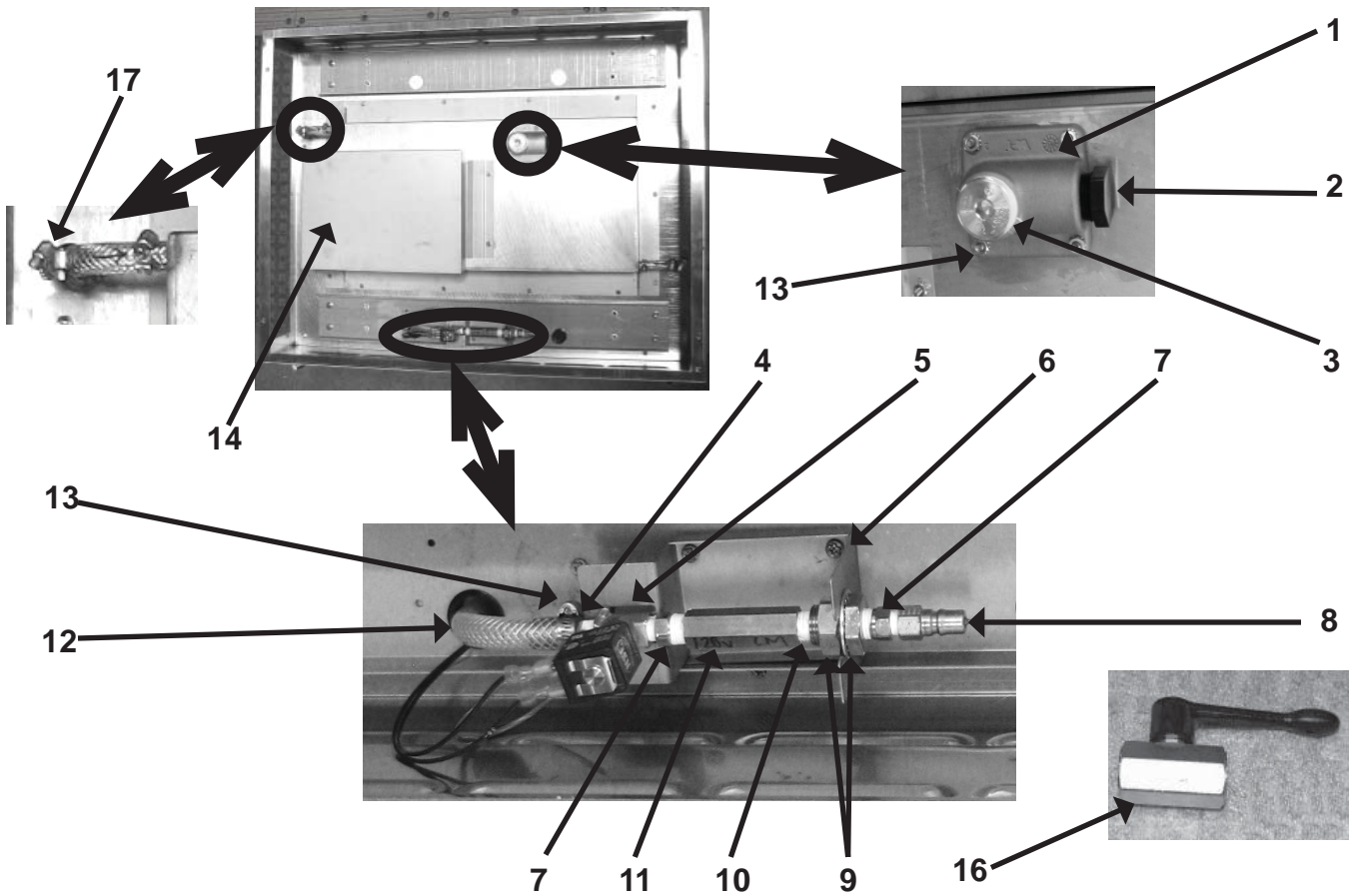

Item No.	Part No.	Description	Quantity
1	22472	Block-Drain	1
2	FP01-009	Pipe Plug-3/4"	1
3	FP01-021	Pipe Plug-1"	1
4	FP01-152	Fitting-Barb	1
√ 5	80701	Valve-Solenoid (120V)	1
√ 5	72117	Valve-Solenoid (220/240V)	1
√ 5	80700	Valve-Solenoid (208V)	1
6	88518	Bracket-Solenoid Bottom	1
7	FP01-012	Nipple Reducing (1/4 TO 1/8)	2
8	FP01-155	Plug - Quick Disconnect	1
9	FP01-013	Bulkhead Adapter	1
10	FP02-009	Nipple-Close	1
√ 11	83514	Strainer-Water	1
12	26968-005	Hose	1
13	MS01-263	Hose Clamp	1
14	64351	Cover - Water Pan Heater	1
√ 15	90470	Gasket - Drain Block	1
√ 16	27539	Flow Valve - AHC-993 ONLY	1
√ 17	64154	Check Valve (All 990's & 993's before 03/01/2011)	1
18*	FP01-154	Socket - Quick Disconnect	1

√ recommended parts/ *not shown

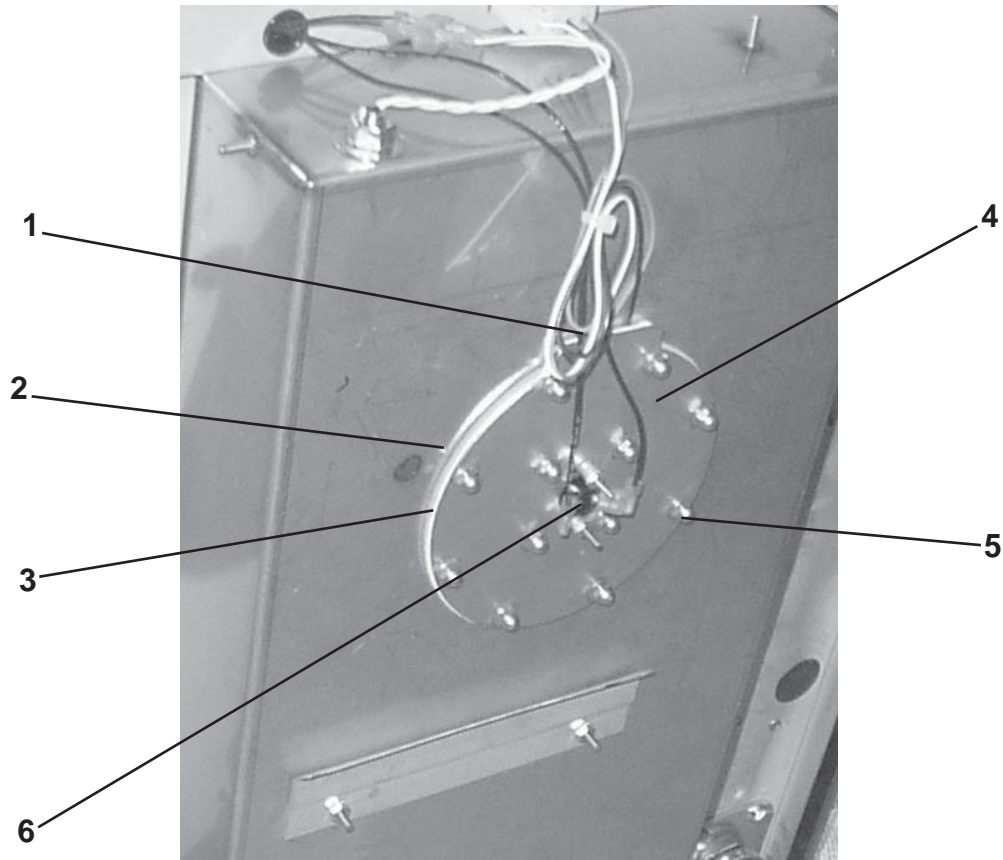

Item No.	Part No.	Description	Quantity
√ 1	14631	Kit - Water Pan Heater - 120V	1
√ 1	14632	Kit - Water Pan Heater - 208V	1
√ 1	14633	Kit - Water Pan Heater - 240V	1
2	71130	Spacer - Water Heater	1
3	68130	Insulator - Water Heater	1
4	67524	Plate - Water Heater Backing	1
5	NS02-007	Nut Hex Keps - #8-32 C	12
√ 6	63831	Hi Limit - Water Pan	1

√ recommended parts

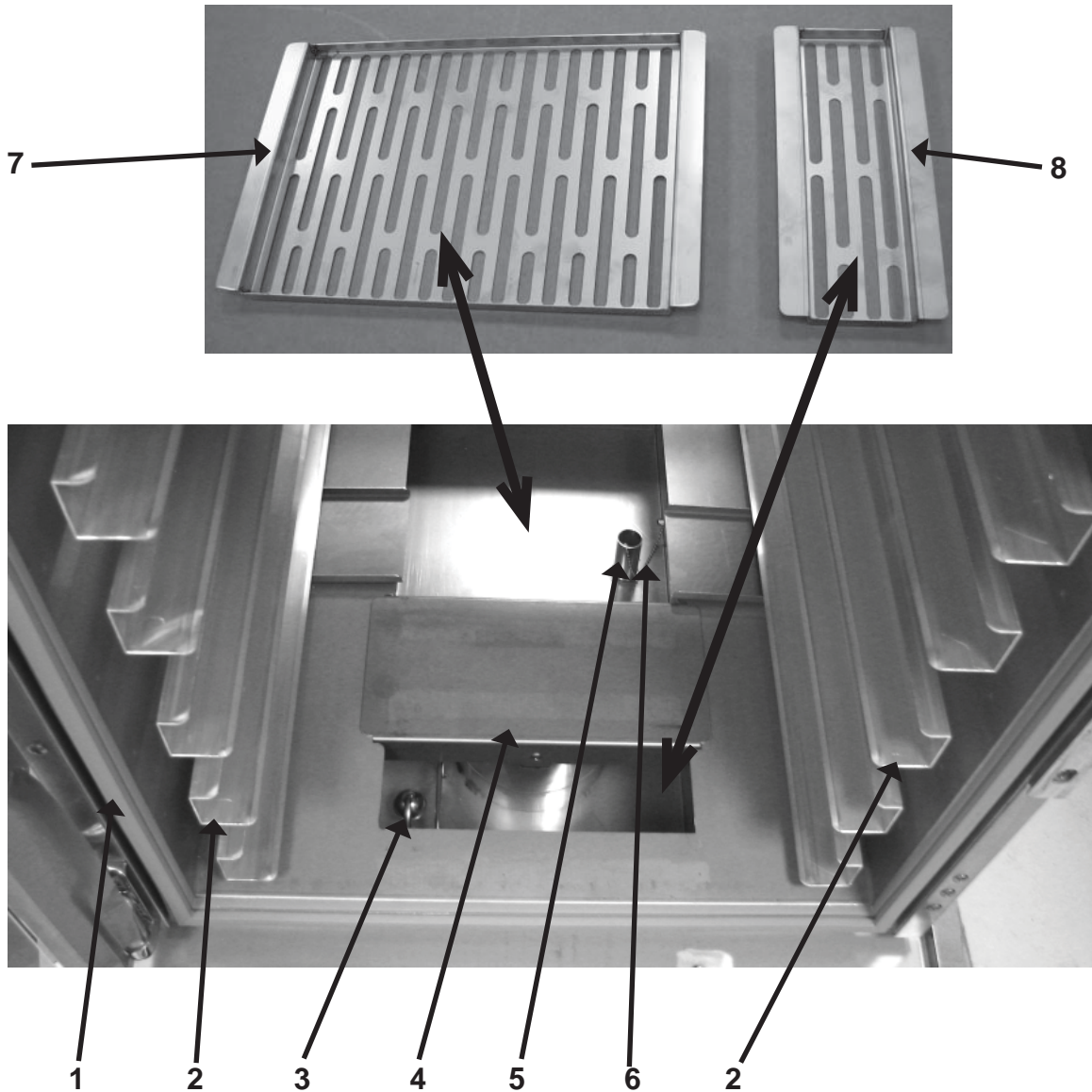

Item No.	Part No.	Description	Quantity
√ 1	25793	Gasket - Door - AHC-993	2
√ 1	25643	Gasket - Door - AHC-990	4
2	87203	Assy. - Air Duct - AHC-993	2
2	27895	Assy. - Air Duct - Upper - AHC-990 - 13 tray	2
2	90784	Assy. - Air Duct - Lower - AHC-990 - 13 tray	2
2	27894	Assy. - Air Duct - Upper - AHC-990 - 10 tray	2
2	90846	Assy. - Air Duct - Lower - AHC-990 - 10 tray	2
√ 3	90749	Switch - Float Assembly	1
4	63525	Assy-Water Pan Cover & Ring (concentration ring)	1
4	SC01-076	Screw - #8-32 x 1/4 PH THD S	8
4	ME50-048	Standoff - .25 dia. x .63 lg. #8-32 SS	4
5	28071	Overflow Tube	1
6	79107	Chain Assy - Retaining	1
7	88933	Cover - Slotted Rear Water Pan (Long)	1
8	88936	Cover - Slotted Front Water Pan (Short)	1

√ recommended parts